

PRODUCT DATA SHEET

RSV4G30D-F40 - 3400 RPM

DESCRIPTION

RSV series are designed to direct drive on gasoline engines ranging from 5 – 13 h.p. Intended use for medium to heavy tasks; this triplex plunger pump features the latest in design and technology. Life tested over 500 hours at maximum performance of 4 gpm at 4,000 psi. The RSV series features a compact and efficient intergraded unloader valve and fixed chemical injector. The RSV is a result of our combined 60 years of pumps building experience and expertise.

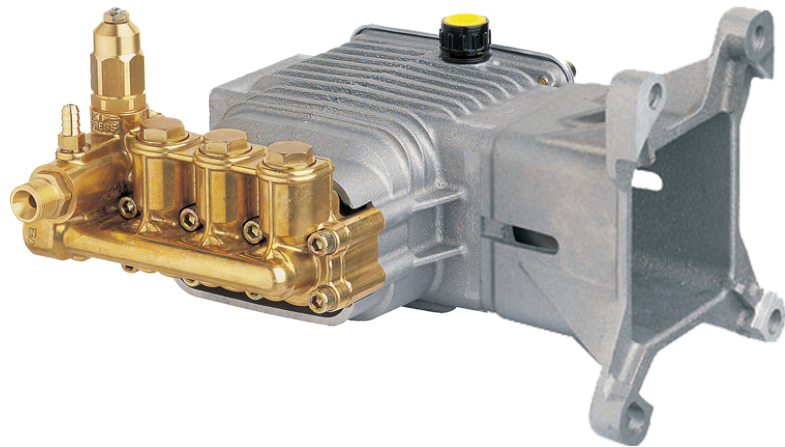

SPECIFICATIONS

MAX GPM	4	MAX LMP	15.1
MAX PSI	3000	MAX BAR	205
POWER EBHP	7.5	BORE DIA. MM	15
STROKE MM	9.4	WEIGHT LBS	14
MAX TEMP	140°	OIL CAPACITY	16oz
INLET THREAD	3/8" F	DISCHARGE THREAD	3/8" F

DIMENSIONS

RSV

D version + F40
Hollow shaft pump \varnothing 1"

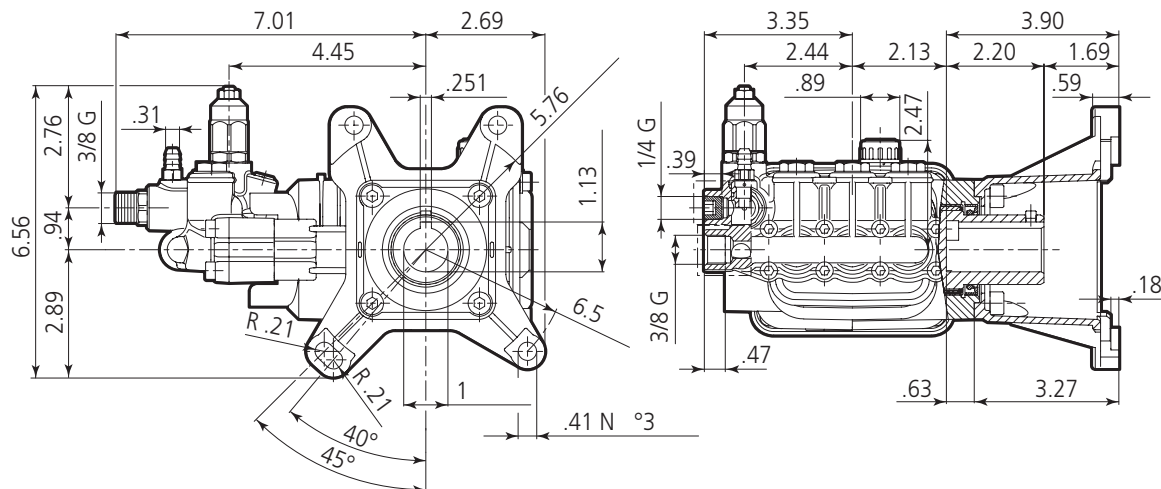

SPECIAL FEATURES

WET END

- **Manifold:**
 - **Forged Brass:** New high efficiency design concept. (Patented) Strength and no porosity = long life. Higher Hydrostatic Pressures - Safety, Performance.
 - **Unloader:** Integral trap pressure, fixed chemical injector. Simple repair using a cartridge replacement kit with built in EZ start valve.
 - **Inlet and Discharge Ports:** Heavy bosses for added strength. 3.8" F Inlet and 3/8" M discharge.
 - **Offset Discharge Ports:** High efficiency, smooth flow.
 - **Bolts:** 8 Bolts, 10mm, grade 8.8
- **Valves:**
 - **Ultra Form Cages:** Durable, strength, and long life.
 - **Poppets, Seat and Spring:** 303 and 400 series stainless steel.
 - **Valve Caps:** Machined brass - greater strength.
- **Packing and Plungers:**
 - **High and Low Pressure Packing:** "V" style (D-1) Buna-N (cotton duct weave base) strong and tightens under load.
 - **Support and Guides:** Machined brass, 1-piece construction and special packing support ring to assure proper plunger alignment and to maximize packing and seal life.
 - **Plungers:** Ceramic coated stainless steel.
 - **Low Pressure Seals:** "U" cup double lip Buna-N, good positive seal.

DRIVE END

- **Bearings:** Oversized for maximum life and load disbursement, needle bearing on the drive side and ball on the non-drive side. Each bearing is held in position on the crankshaft and crankcase by snap rings. This assures positive alignment and centering of the connecting rods and crankshaft in relation to the crankcase, it also eliminates the crankshaft from floating.
- **Crankcase:** Precision die-cast, large cooling fins and anodized (for maximum heat dissipation).
- **Rear Cover:** Precision stamped steel O-Ring seal.

- **Plunger Rods:** Stainless steel construction for strength (no plating to scrape off), O-Ring plunger sealing system.
- **Rod Pins:** Precision ground and hardened steel, oversized for load disbursement.
- **Connection Rods:** One piece special allow aluminum and bronze based, oversized for maximum strength, load disbursement, and life. Heavy pin area construction, for added load strength.
- **Crankshaft:** Forged, precision ground and hardened for extremely long life and durability. Available in 3/4" and 1" hollow shafts. Shaft key set screw are standard on high speed version for long shaft life.
- **Oil Seals and O-Rings:** All are constructed of Buna-N rubber. The O-Rings have stainless steel garder springs to assure constant tension on the sealing surface.
- **Ports and Oil Drain:** One 1/4" discharge accessory port and on 1/4" inlet accessory port. One crankcase bottom drain plug.
- **Oil Capacity:** 16 oz.

EXTRA FEATURES

- **Dyno Proven:** All pumps are dyno tested to assure the theoretical design meets the actual design.
- **Valve Design:** Each pump series has a valve design that optimizes its highest efficiency.
- **Wet End Repair:** Very simple no special tools are required.
- **Mounting Flanges:** SAE j609A and j609B
- **Design Uses:** Using Advanced Fluid Handling Design Programs, overall pump efficiency is increased.